

Article number: 203180M1675C4V

Description: E+G levelling foot

GN 31-80-M16-75-C4-V

Note: V Without nut, External hexagon at the top, Wrench flat at the bottom

Measures

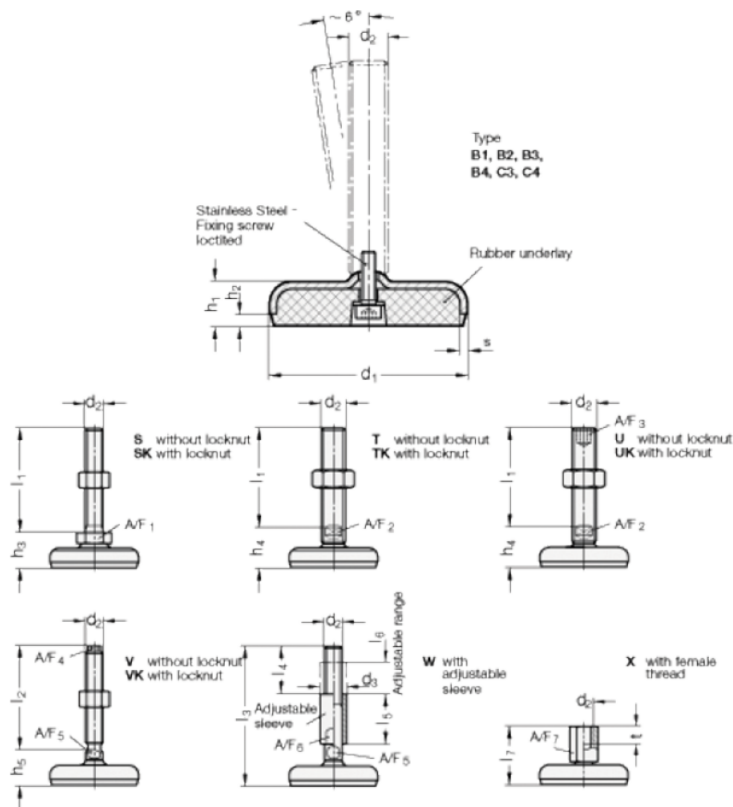

A/F4	= 10	s = 3
A/F5	= 12	
d1	= 80	
d2	= 16	
h1	= 18	
h2	= 5	
h5 +4.0/0	= 29	
l2	= 75	